

Meridian Panel

Product Data

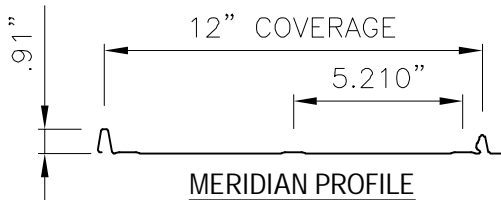

MERIDIAN PROFILE
(Striated or Minor Ribs)
(Minor Ribs Shown)

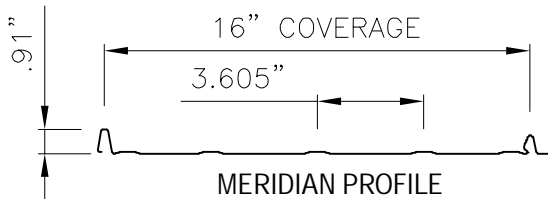

MERIDIAN PROFILE
(Striated or Minor Ribs)
(Minor Ribs Shown)



MERIDIAN PROFILE
(Striated or Minor Ribs)
(Striated Shown)

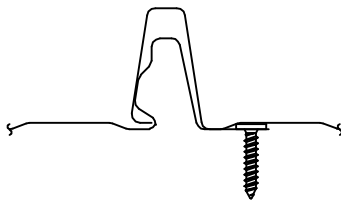

MERIDIAN SEAM

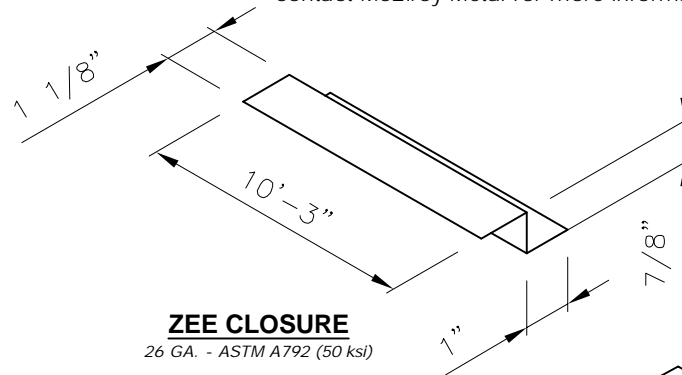

ZEE CLOSURE

26 GA. - ASTM A792 (50 ksi)



FOAM SEAM PLUG

Applications

Snap Seamed roof panel used on slopes down to 3:12. Standard panel lengths up to 45'. Please inquire for longer lengths.

Substrates

Plywood or Rigid Insulation/Metal Deck.

Material

Standard - 24 GA. or 26 GA. ASTM A792 (50 ksi steel)
AZ55 - Bare, AZ50 - Painted

Manufacturing

Roll formed in factory.

Finishes

Acrylic Coated Galvalume®
Fluoropolymer (Kynar 500® PVDF resin-based)

Pan Conditions

16" Minor Rib or Striated - 24 or 26 ga.
12" Minor Rib or Striated - 24 ga. only
Oil canning is inherent in all metal panels and is not cause for panel rejection. A signed oil canning acknowledgement will be required for all orders prior to production.

Testing *

Uplift: UL 580 Class 90
Air & Water Infiltration: ASTM E1680, and ASTM E1646.
Fire Resistance: UL 790 Class A
Impact Testing: UL2218 Class 4
Florida Product Approval: FL 2358.1
Texas Windstorm: RC-34
Testing and Approvals are product specific. Please inquire for details.

NOTE:

All data represented on this sheet may not be applicable to all widths and gauges. Please contact McElroy Metal for more information.

TECHNICAL BULLETIN









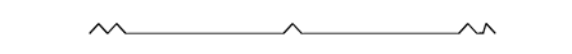
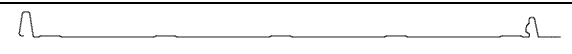

Issue Date : June 1, 2006

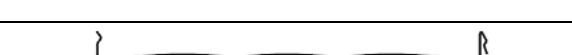
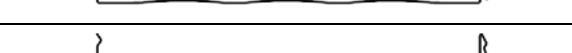
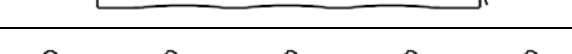
Revised: August 17, 2020

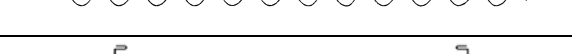
No. 04-268-06

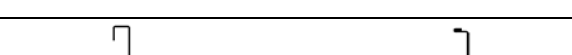
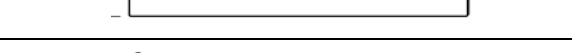
Texas Department of Insurance Approval

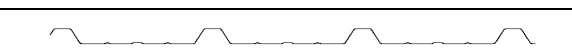
The following roofing products have been evaluated by the Texas Department of Insurance for being in compliance with the *International Residential Code* (IRC) and the *International Building Code* (IBC).

Panel Name	Minimum Gauge	Product Evaluation Number	Panel Profile
5V-Crimp	26	RC-13	
Meridian	26	RC-34	
Multi-Rib	26	RC-63	
ABC Instaloc	24	RC-86	
ABC InstaLoc	26	RC-93	
MaxRib	29	RC-157	
Multi-Cor	26	RC-158	
ABC 238T	24	RC-270	
ABC JSM 200 DL	24	RC-271	
ABC Permaseam	24	RC-272	
MultiRib	26	RC-283	
PBR-Panel	26	RC-284	
Met Tile	26	RC-425	
Milan	29	RC-463	
Medallion-Lok	24	RC-573	

For additional information and verification please visit <http://www.tdi.state.tx.us/wind> .

MANUFACTURING LOCATIONS

ADELANTO, CA ASHBURN, GA BOSSIER CITY, LA CLINTON, IL DIAMOND, MO HOUSTON, TX LEWISPORT, KY
 MARSHALL, MI MAUSTON, WI MERKEL, TX PEACHTREE CITY, GA SUNNYVALE, TX WINCHESTER, VA



TECHNICAL BULLETIN

Issue Date : June 1, 2006

Revised: August 1, 2017

No. 04-267-06

Tests for Impact Resistance of Roof Covering Materials

UL 2218

Impact Resistance Class 4

Class 4 formed coated Steel Panels designated Type Coated steel panels (surfacing) identified as “Multi-Rib”, “Master-Lok”, “R”, “Medallion-Lok”, “Medallion”, “Medallion I Batten”, “Medallion II Batten”, “Meridian”, “5V-Crimp”, “Mega-Rib”, “Maxima 1.5”, “Maxima 212”, “Maxima 216”, “Maxima 218”, “Maxima 318”, “Maxima 324”, “Metalogic-2000”, “Mirage”, “M-Cor”, “Multi-Cor”, “Max-Rib”, “Mac-Rib”, “U”, “PBU”, “Mirage II”, “Maxima ADV”, and “Met-Tile”, “ABC Permaseam Panel;”, “ABC SL Low Panel”, ABC JSM 200”, “ABC Instaloc”, ABC SERIES 300”, “238T Roof Panel”, and “138T Roof Panel”.

Class 4 formed copper panel, designated “ABC JSM 200”

Class 4 formed aluminum panel, designated “ABC 238T Roof Panel” and “Medallion-Lok”.

CORPORATE OFFICE
SHREVEPORT, LOUISIANA

BOSSIER CITY, LA
CLINTON, IL

PEACHTREE CITY, GA
MARSHALL, MI

WINCHESTER, VA
ADELANTO, CA

LEWISPORT, KY
MAUSTON, WI

ASHBURN, GA
MERKEL, TX

SUNNYVALE, TX
HOUSTON, TX



TECHNICAL BULLETIN

Issue Date : June 1, 2006

Revised : April 24, 2017

No. 04-266-06

Tests for Fire Resistance of Roof Covering Materials UL 790 (ASTM E108 and NFPA 256)

Class A

Coated Steel Panels (surfacing) identified as "Multi-Rib", "Master-Lok", "R", "Medallion-Lok", "Medallion", "Medallion I Batten", "Medallion II Batten", "Meridian", "5V-Crimp", "Mega-Rib", "Maxima 1.5", "Maxima 212", "Maxima 216", "Maxima 218", "Maxima 318", "Maxima 324", "Metalogic-2000", "Mirage", "M-Cor", "Multi-Cor", and "Max-Rib", "U", "PBU", "Mirage II", "Maxima ADV", "Met-Tile", "ABC Perma seam Panel", "ABC SL Low Panel", "ABC JSM 200", "ABC Instaloc", "ABC Series 300", "238T Roof Panel", and "138T Roof Panel".

Copper panels (surfacing) identified as "ABC JSM 200".

Aluminum panels (surfacing) identified as "ABC 238T Roof Panel" and "Medallion-Lok".

- 1. Deck:** C-15/32 **Incline:** Unlimited **Impact:** Class 4
Barrier Board: - Georgia Pacific ¼ in. min " Densdeck" board or ¼" min United States Gypsum Co SECURELOCK® Glass-Mat Roof Board (Type SGMRX), National Gypsum "DEXcell Glass Mat Roof Board" or " DEXcell FV Glass Mat Roof Board", CertainTeed Gypsum "GlasRoc" or ½ in. min UL classified gypsum board with all joints staggered a min of 6 in. from the plywood joints.
Ply Sheet (Optional): - Any UL Classified Type G1, G2 or G3 base/ply sheet, Type 15, 20 or 30 felt or UL Classified prepared roofing accessory or GCP Applied Technologies "Ice and Water Shield".
Surfacing: - Coated Steel, Aluminum, or Copper roofing panels, mechanically fastened or with steel screws when roof deck fasteners (panel clips) not required.
- 2. Deck:** NC **Incline:** Unlimited **Impact:** Class 4
Barrier Board (optional): - ¼ in. (min) G-P Gypsum Densdeck® United States Gypsum Co SECURELOCK ®, Glass Mat Roof Board (Type SGMRX), National Gypsum "DEXcell Glass Mat Roof Board" or " DEXcell FV Glass Mat Roof Board", CertainTeed Gypsum "GlasRoc".
Ply Sheet (Optional): - Any UL Classified Type G1, G2 or G3 base/ply sheet, Type 15, 20 or 30 felt or UL Classified prepared roofing accessory or GCP Applied Technologies "Ice and Water Shield".
Surfacing: - Coated Steel, Aluminum, or Copper roofing panels, mechanically fastened or with steel screws when roof deck fasteners (panel clips) not required.
- 3. Deck:** NC **Incline:** Unlimited **Impact:** Class 4
Barrier Board (optional): - 7/16 OSB or 5/8 in. plywood over polyisocyanurate insulation board or polyisocyanurate composite board, any thickness.
Ply Sheet (Optional): - Any UL Classified Type G1, G2 or G3 base/ply sheet, Type 15, 20 or 30 felt or UL Classified prepared roofing accessory or GCP Applied Technologies "Ice and Water Shield".
Surfacing: - Coated Steel, Aluminum, or Copper roofing panels, mechanically fastened or with steel screws when roof deck fasteners (panel clips) not required.
- 4. Deck:** NC **Incline:** Unlimited **Impact:** Class 4
Barrier Board (optional): - Polyisocyanurate, glass fiber, perlite, or wood fiber, any thickness.
Ply Sheet (Optional): - Any UL Classified Type G1, G2 or G3 base/ply sheet, Type 15, 20 or 30 felt or UL Classified prepared roofing accessory or GCP Applied Technologies "Ice and Water Shield".
Surfacing: - Coated Steel, Aluminum, or Copper roofing panels, mechanically fastened or with steel screws when roof deck fasteners (panel clips) not required.
- 5. Deck:** NC **Incline:** Unlimited **Impact:** Class 4
Insulation: - None Required, however any UL Classified insulations may be over open purlin spans. Any combination and any total thickness of insulation may be used.
Surfacing: - Coated Steel, Aluminum, or Copper roofing panels, mechanically fastened or with steel screws when roof deck fasteners (panel clips) not required.
- 6. Deck:** C-15/32 **Incline:** Unlimited **Impact:** Class 4
Barrier Board: - Georgia Pacific ¼ in. min " Densdeck" board or ¼" min United States Gypsum Co SECURELOCK® Glass-Mat Roof Board (Type SGMRX), National Gypsum "DEXcell Glass Mat Roof Board" or " DEXcell FV Glass Mat Roof Board", CertainTeed Gypsum "GlasRoc" or ½ in. min UL classified gypsum board with all joints staggered a min of 6 in. from the plywood joints.
Ply Sheet (Optional): - Any UL Classified Type G1, G2 or G3 base/ply sheet, Type 15, 20 or 30 felt or UL Classified prepared roofing accessory or GCP Applied Technologies "Ice and Water Shield".
Surfacing: - Coated Steel, Aluminum, or Copper roofing panels, mechanically fastened or with steel screws when roof deck fasteners (panel clips) not required.

Class C

- 1. Deck:** C-15/32 **Incline:** No Limitations **Impact:** Class 4
Surfacing: - Coated Steel roofing panels, mechanically fastened or with steel screws when roof deck fasteners (panel clips) not required.

Maintenance and Repair

Class A, B, or C

- 1. Deck:** C-15/32 **Incline:** No Limitations **Impact:** Class 4

Existing Roof System: - (to maintain existing Classifications) Class A, B or C smooth or mineral surfaced cap sheet or asphalt glass mat shingles or organic felt shingles.

Ply Sheet (Optional): - Type 15 or 30 organic felt or UL classified self-adhering modified bitumen membrane.

Surfacing: - Coated Steel "138T Roof Panel", mechanically fastened or with steel screws when roof deck fasteners (panel clips) not required.

**CORPORATE OFFICE
SHREVEPORT, LOUISIANA**

BOSSIER CITY, LA	PEACHTREE CITY, GA	WINCHESTER, VA	LEWISPORT, KY	ASHBURN, GA	SUNNYVALE, TX
CLINTON, IL	MARSHALL, MI	ADELANTO, CA	MAUSTON, WI	MERKEL, TX	HOUSTON, TX



TECHNICAL BULLETIN

Issue Date : June 1, 2006

No. 03-263-06

UL Construction #529

Meridian

UL580 Class 90

1. **Metal Roof Deck Panels*** - No. 29MSG min coated steel. Max panel width 24 in. rib height nominal 1 in. Panels continuous over two or more spans. A bead of sealant may be used at panel end laps.
McElroy Metal Mill, Inc. "Meridian"
2. **Fasteners** – (Screws) - For panel attachment to wood deck (Item 3) fasteners to be No. 10 x 1 in. long No. 2 Phillips Pancake head type A. Fastener spacing to be 12 in. OC with fasteners installed through prepunched slots in fastener flange of panel. For attachment of plywood deck (Item 3) to joists (Item 5), fasteners to be min No. 6 by 1-7/8 in. bugle head screw or annular ring-shank nails. Spacing to be 6 in. OC at plywood edges and 12 in. OC at intermediate supports. When light gauge structural steel joists are used, fasteners to be No. 12 by 1-5/8 in. long with a Phillips head.
3. **Substructure** – (Plywood) – Plywood decking to be a nom 5/8 in. thick, exposure sheathing span C-D, 40/20 plywood. All butt joints to be sealed against leakage by using tape and/or caulk or with one-part urethane sealant.
4. **Moisture Barrier** – (Optional) – Any suitable membrane to protect substructure (Item 3).
5. **Joists** – Joists spaced at 2 ft., 0 in. OC may be one of the following:
 - A. Nom 2 by 6 in. wood joists No. 2 or better.
 - B. Nom 2 by 4 in. wood when used on top cord of a wood truss, No. 2 or better.
 - C. Light gauge structural steel framing with the member against the plywood to be a min. No. 22 MSG coated steel.

Refer to General Information, Roof Deck Construction, (Roofing Materials and Systems Directory) for items not evaluated.

*Bearing the UL Classification Marking

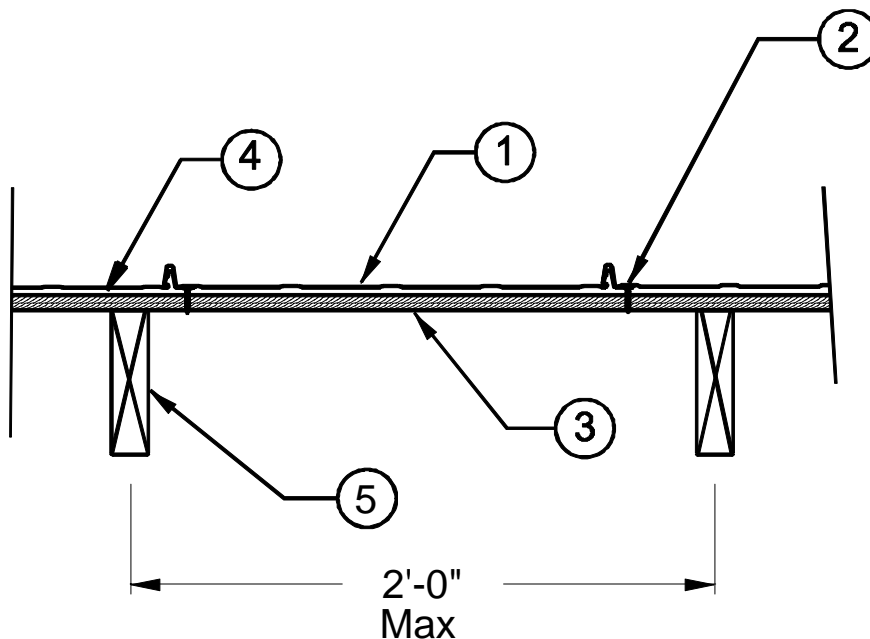

CORPORATE OFFICE
SHREVEPORT, LOUISIANA